

Ek-5

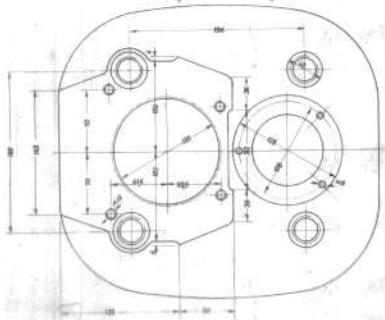

~ (v, vv)

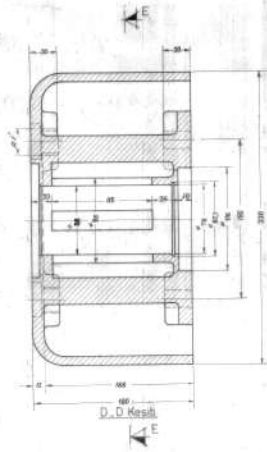
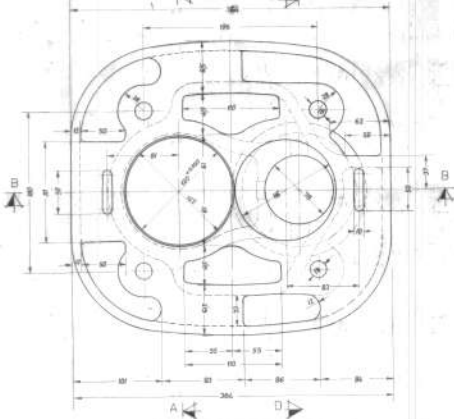
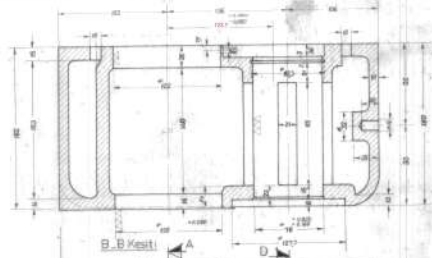
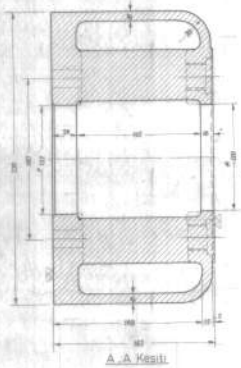
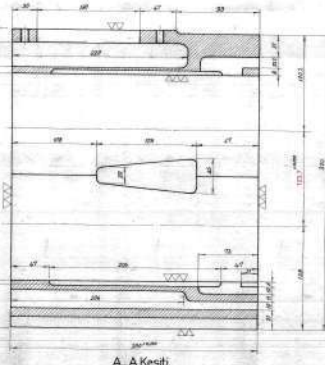
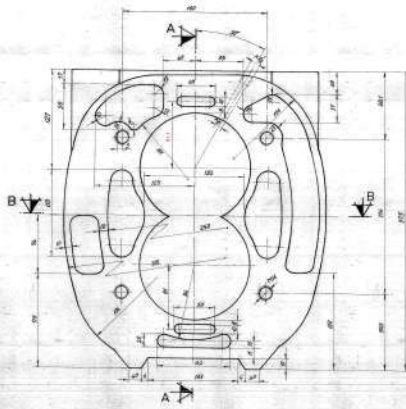

A-A Kesiti

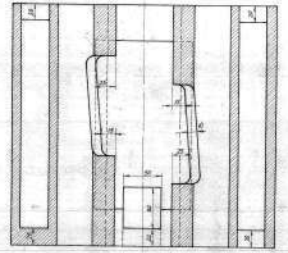
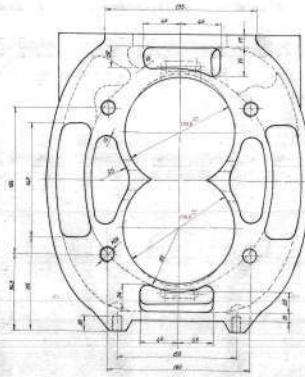

B-B Kesiti

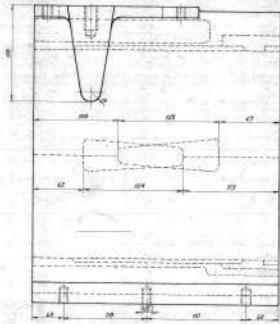
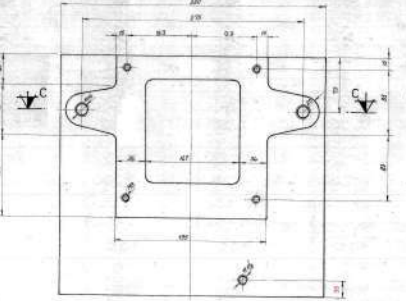

C-C Kesiti

0025	1	15 HP HANGI MOTORU	A. 390. II
0025	12	GOVDESİ	

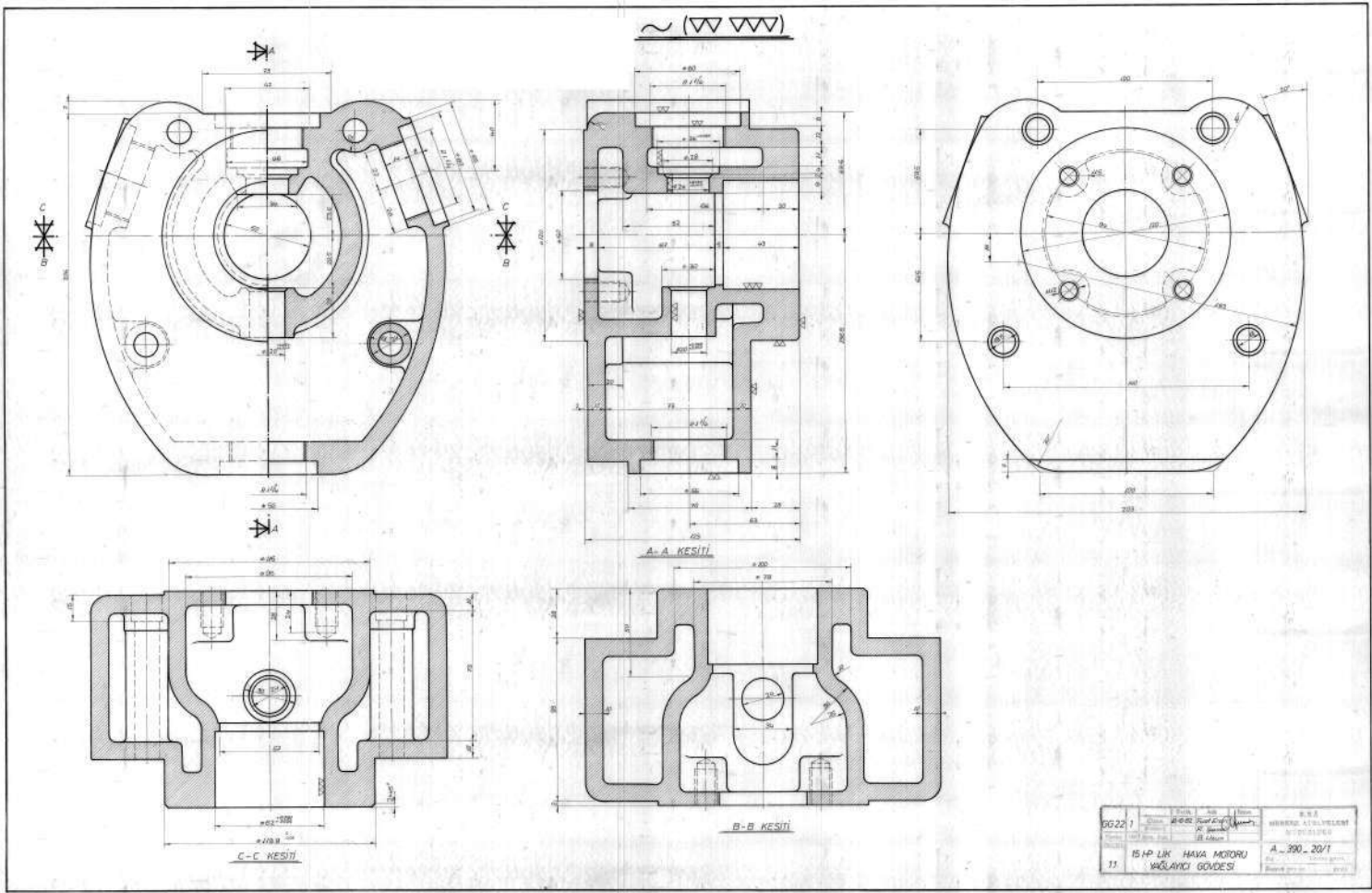

06221	15 HP LİK HAVA MOTORU	HAVA MOTORU	15 HP LİK HAVA MOTORU	15 HP LİK HAVA MOTORU
17	KÖLÇANCI GÖVDESİ	15 HP LİK HAVA MOTORU	15 HP LİK HAVA MOTORU	15 HP LİK HAVA MOTORU
			A-390-20/1	

Ek-5

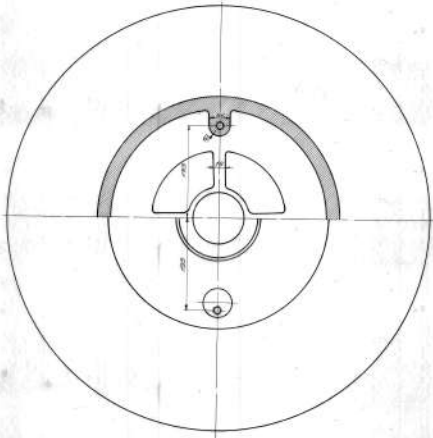

A-A KESİTİ ve BAKIŞI

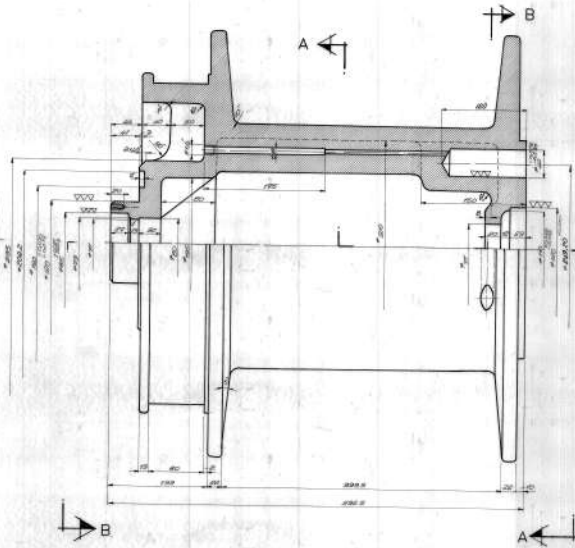
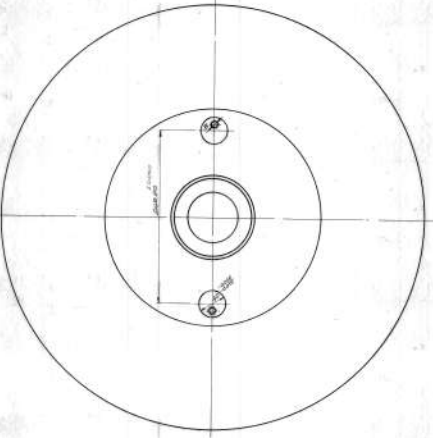

B

A

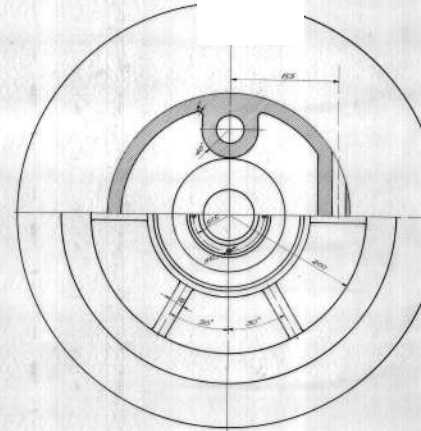

B-B KESİTİ ve BAKIŞI

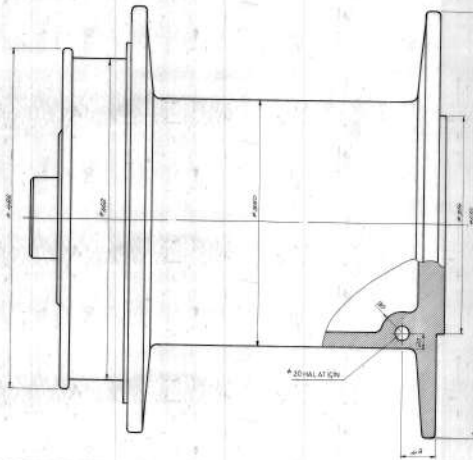

00 21

~(▽▽▽)

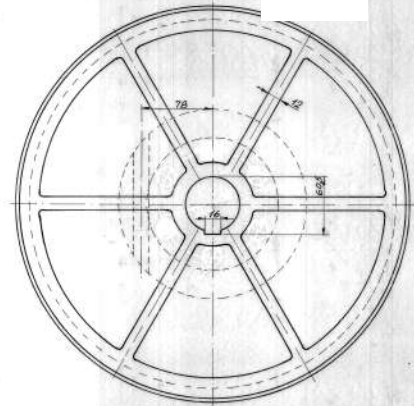
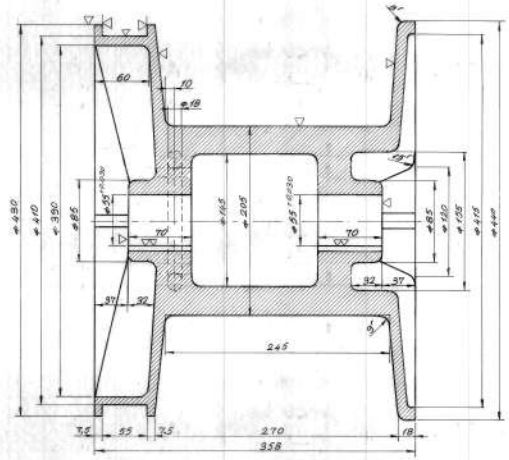
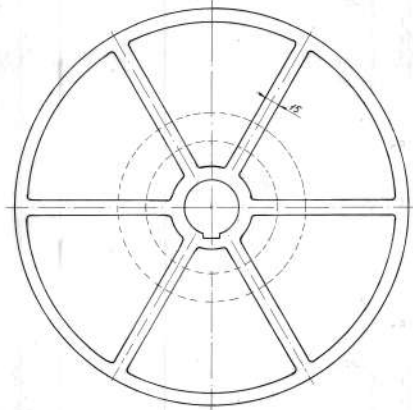

GO 25	1	YERİ	Adı	Y.T.B.
		84.731	M. Yıldız	MADEN MAKİHALARI
			C. Bülent	FABRİKA İŞLETME
			B. Uzun	MÜDÜRLÜĞÜ
ŞİŞLİ				F_639_3
125				15 HP MANEVRA VİNCİ
				TAMBURU

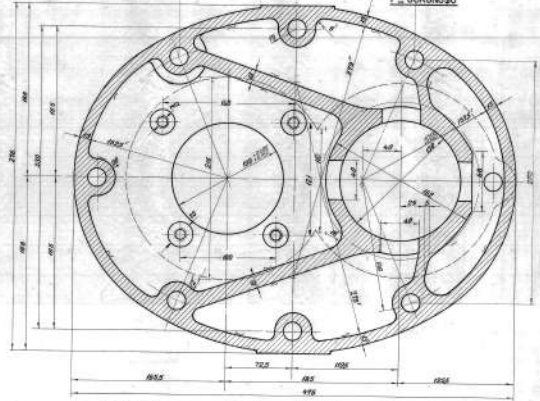
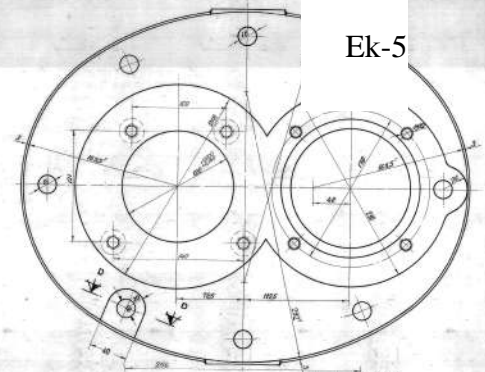
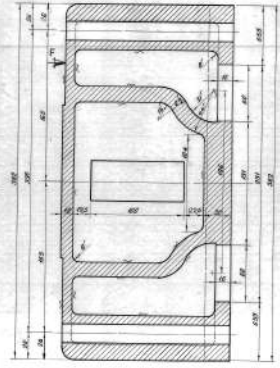
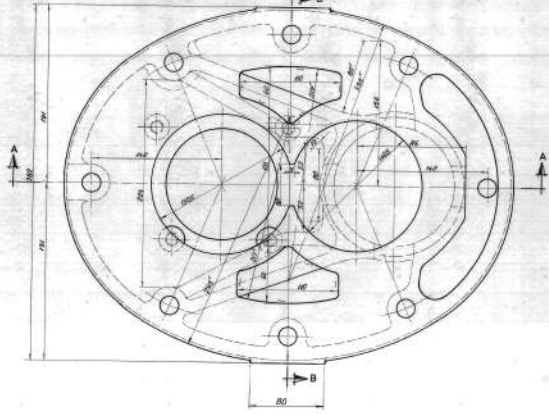
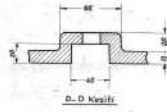
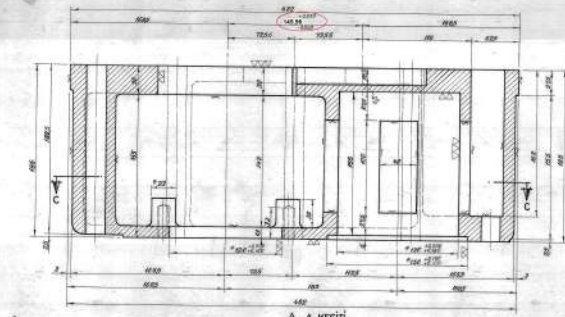

GG25	Çizim	Reviz	İnce	MOTOR TAHSİSLARA
MOZEMER	Çizim	Reviz	İnce	ÇİZİM VE TAHSİSLER
				MERKEZİ
Adet	Üçerik	20 HP İK HAVVA	MOTORU	F. EB. 10
1	1/2	KAPAKI		

~(▽.▽▽)

Ek-5

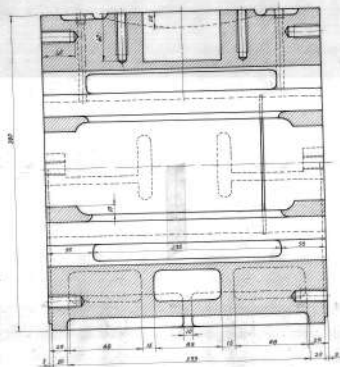
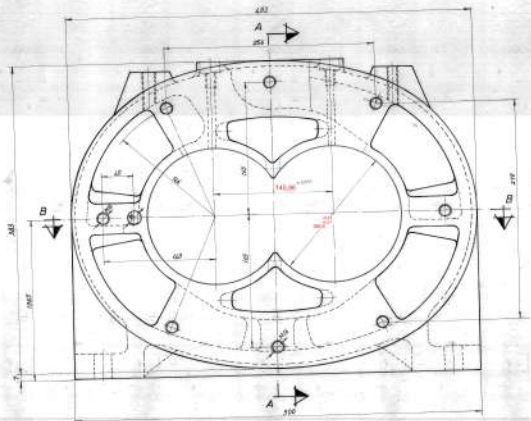

A. A Kesit

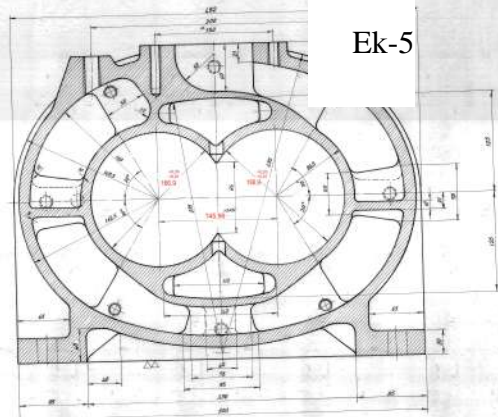

C. C Kesit

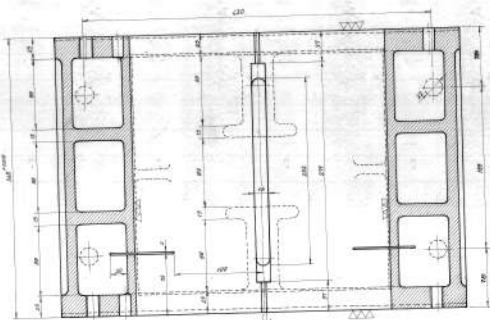
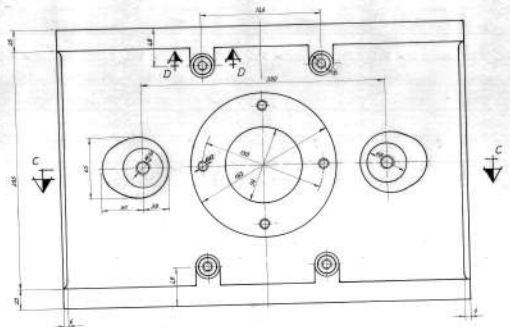

B. B Kesit

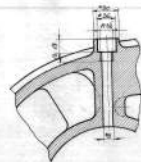

D. D Kesit

9020	1	20 HP NAMA MOTORU	70mm	2000
92		BONDESİ		

Ek-5

~ (▽▽▽)

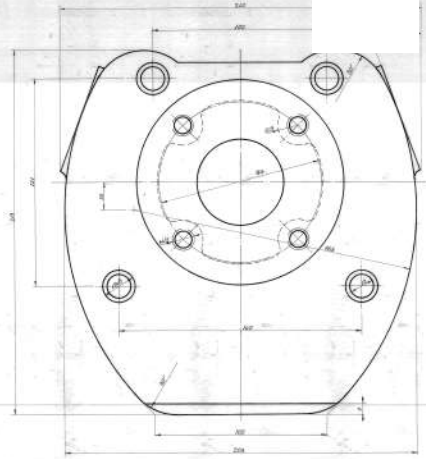
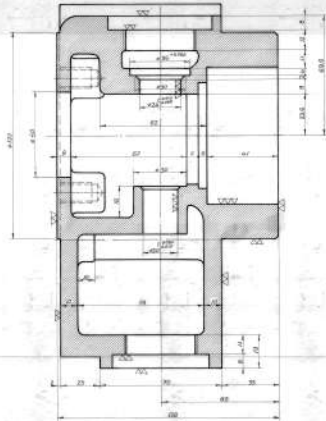
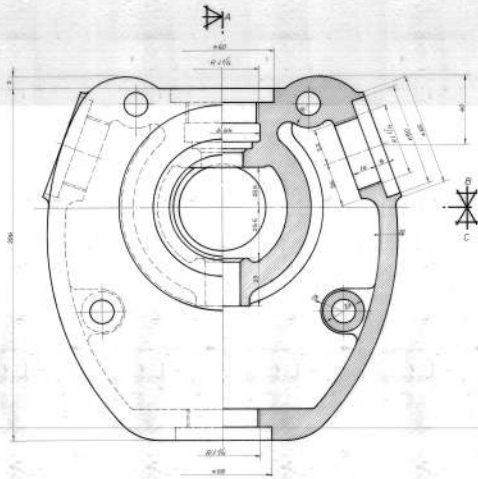

▽

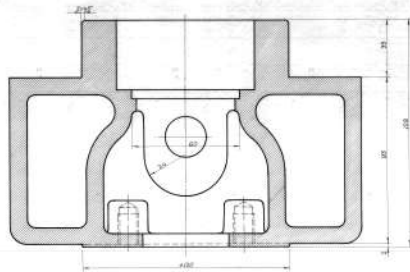
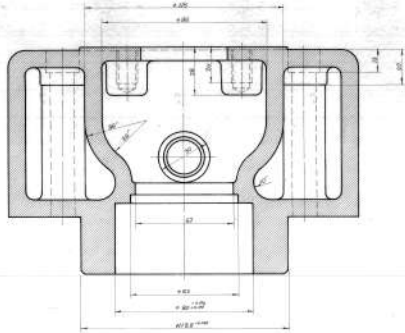

B-B KESİTİ

C-C KESİTİ

5528	1	20 HP'LIK MARA MOTORU YILDIRICI GÖVDESİ	0,1	MİRZELER AŞI TEŞEER MÜHÜRÜ
1.1				F. 819 - 1971